

Friends Help a Lame Man

Mark 2:1-12

Our Bible tells about a man who was lame. That means he couldn't walk. He couldn't even stand up! He could only lie on his mat and wait for his kind friends to help him. The sick man wanted to be well—to sit up, to stand and to walk all by himself!

One day this man's four friends heard that Jesus was in their town. "If only he could go to see Jesus," the friends must have said to each other. "Surely Jesus could make our friend well!"

So the four friends picked up the man on his mat. They carried him as they walked down the road to see Jesus. But when they got to the house where Jesus was talking, it was packed full of people. Many people wanted to see Jesus. There wasn't any room inside! People were even standing in the doorway. Other people stood outside, looking in the windows.

The four friends must have felt sad. There was just no way to get in—not even for one person and especially not for the four of them and their friend lying on his mat.

Then the friends remembered the flat roof on top of the house. The friends climbed the stairs outside the house to the roof. They carried their friend with them. The four friends began to pull away pieces of the roof. Finally the hole was big enough! Carefully the friends lowered the man down, down into the house. Soon he was right in front of Jesus.

Jesus loved the man. "Stand up, take your mat, and walk," Jesus told him. And the man did just that! How happy he was that Jesus had made him well! How thankful he was for his kind friends! All the people in the house were surprised! All the people thanked God.

Bible-Times Houses

Collect

Bible, small paper bags, scissors, paper, ruler, markers, transparent tape.

Prepare

For each child, cut a paper bag in half (see sketch a). For each child, cut a 3x10-inch (7.5x25.5-cm) strip of paper. Accordion-fold each strip into steps (see sketch b).

Do

With paper bags folded flat and the bottom of the bag at the top, children use markers to draw windows and a door. Children open paper bags and turn upside down to form Bible-times houses. (Optional: Children cut doors open.) Assist children to tape paper stairs to the sides of their houses (see sketch c).



Talk About

- ☀ Our Bible tells us about four men who had a friend who couldn't walk. The four men took their friend to see Jesus. Jesus was kind and made the man well. Jesus was staying in a house that had a flat roof. Let's make houses with flat roofs, too!
- ☀ Brynne, I see you handed Marta a marker. You know how to help others! Helping others is a good way to be kind.
- ☀ Jesus teaches us to be kind to others. He will help us to be kind, even when it is hard. What are some ways for you to be kind, Oscar?

Enrichment Ideas

1. Cut a three-sided opening in the roof of each paper-bag house. Older children use toy people to act out the story action as you briefly retell story events. Expect to repeat the story several times as children complete their houses.

2. Instead of making individual houses, provide a cardboard box. Fold paper and tape to side of box to make stairs as described above. Children use markers to decorate box. (Note: Provide one box for every group of three or four children.)

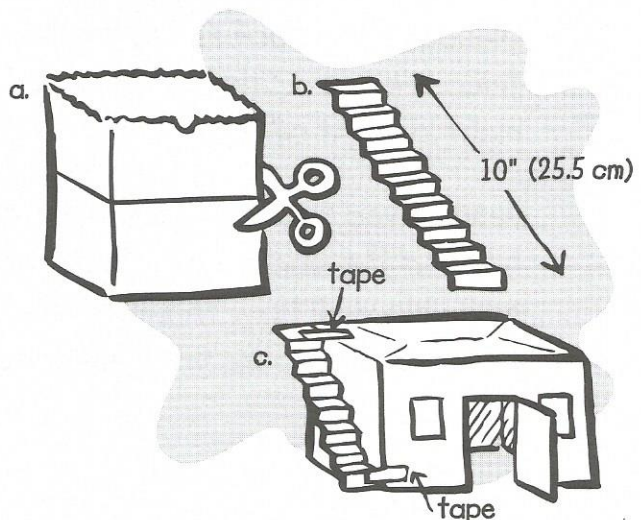

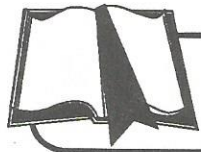

Helpful Friends

Mark 2:1-12

A man lived in Capernaum who could not walk, or run, or jump as you can. His four friends decided to take him to Jesus. They had heard about the miracles Jesus could do. The friends made a pallet, or traveling bed, to carry the man to Jesus.

Make a Pallet

Jesus healed the man, just as the man's friends believed He would.

You can make a pallet or traveling bed for the man. Put the sick man gently on your pallet and glue him in place so he can go and be healed by Jesus.

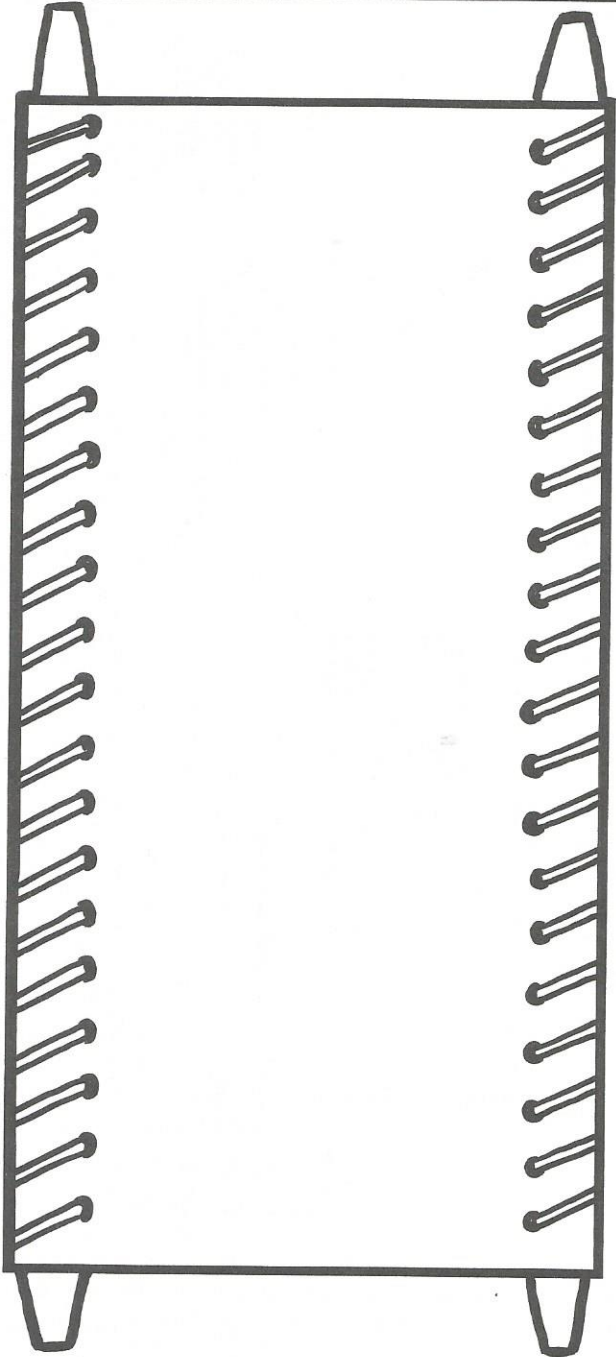

Finished Pallet

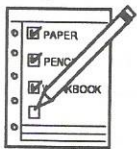
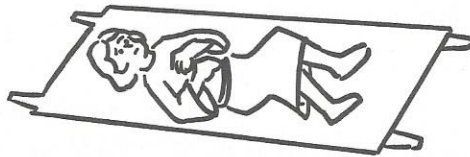

For the Teacher: After the children color, help them cut out pallets and men. Cut two straws in half for each child. Tape straws to pallet corners. Help the children glue the paralyzed men on the pallets. Thank God together for helpful friends. NOTE: You may want to use the pallets for the next Helpful Friends lesson, too. If so, collect them at the end of class and hand them out after children make stethoscopes in the next lesson.

Make a Stethoscope

Helpful Friends

Mark 2:1-12

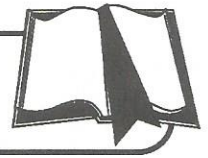

The sick man needed friends to carry him to Jesus. We all need friends. God gives us friends to take care of us and help us in special ways.

A doctor is one of our special friends. Doctors often help people who have become sick.

Pretend to be a doctor, stopping to help the sick man. You can make a stethoscope to listen to his heart. Thump, thump, thump. Can you hear it beating? Take turns listening to your friends' hearts, too.

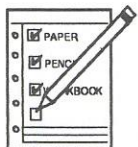
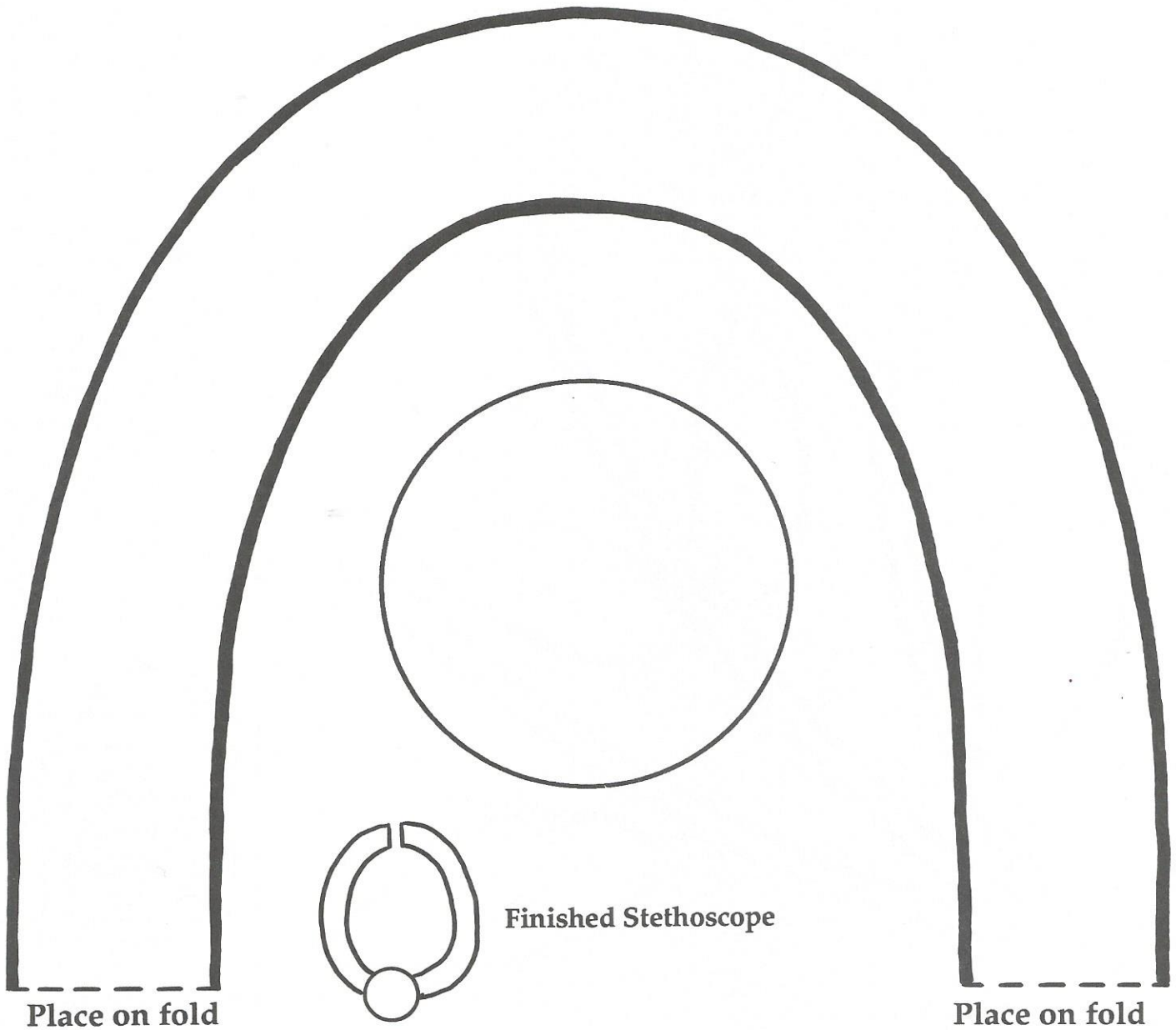

For the Teacher: Fold a piece of black construction paper in half, and pre-cut a stethoscope and a circle for each child. Unfold the stethoscope and cut a 1-inch piece from one end. Let children wrap foil around the circles and glue or tape them to the stethoscopes. Show children how to put the paper around their necks and pretend to listen to each other's heartbeat. Thank God together that we can be kind helpful friends.

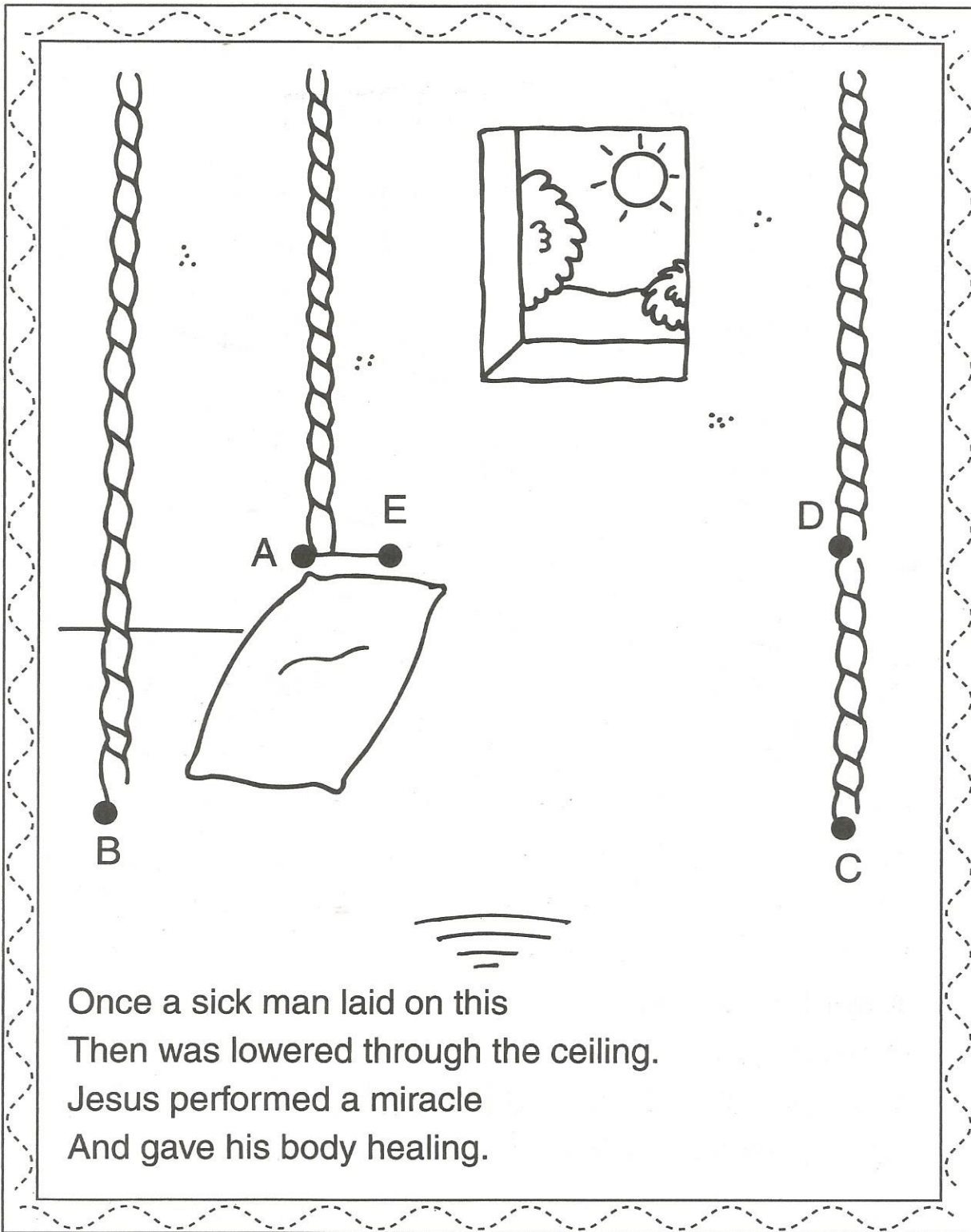

Once a sick man laid on this
Then was lowered through the ceiling.
Jesus performed a miracle
And gave his body healing.



The men made a hole in the roof and let their sick friend down.
Jesus made him get well right away.

Mark 2:1-12